



# FRX

# Quick Start Guide





# Items in the Package

1. Smart Lawn Mower

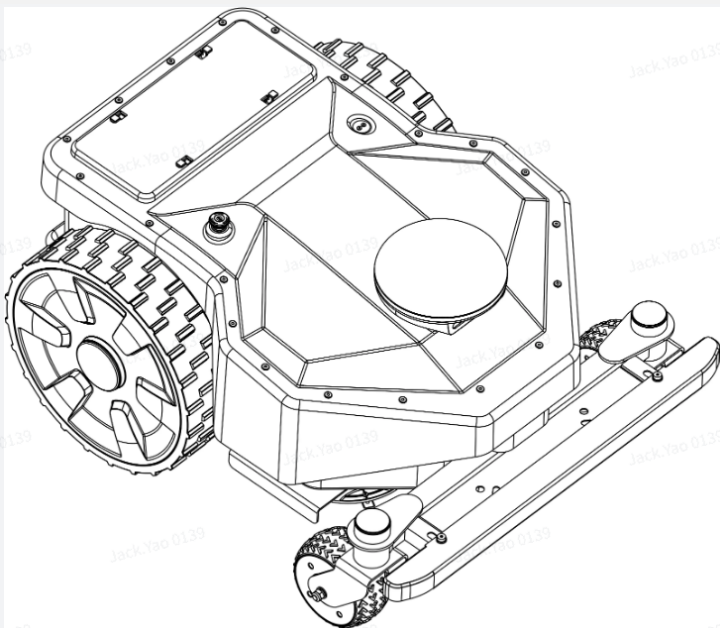

2. Power Adapter and Cable

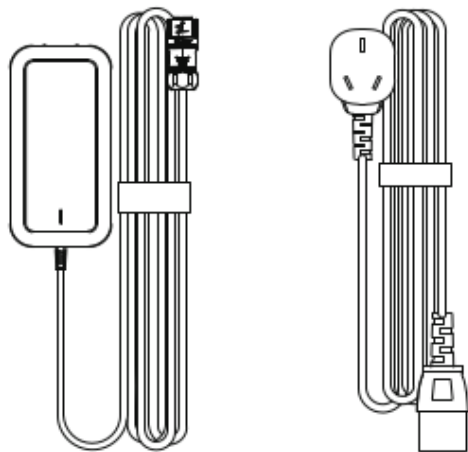

3. Emergency charging cable

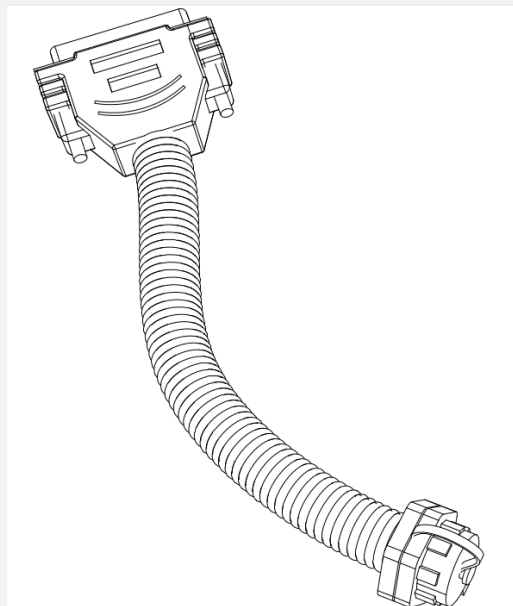

4. Toolkit

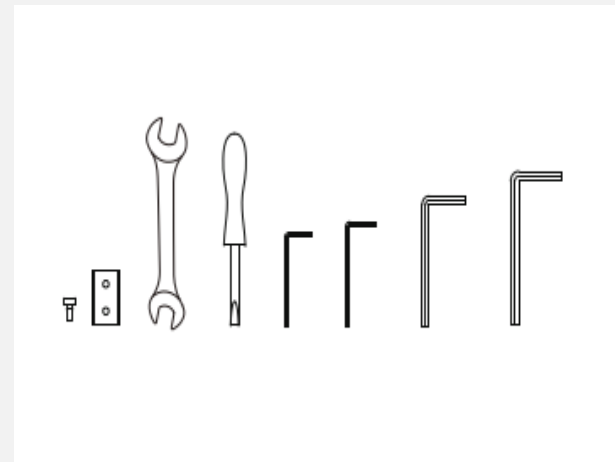



# Download the app & Connect the lawn mower

1. Download the app & Connect the lawn mower



2. Register Account and Login

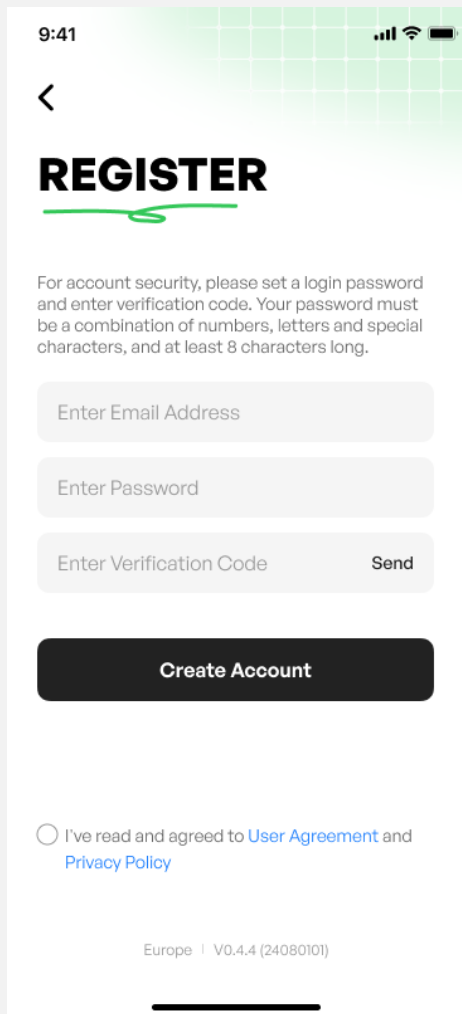

3. Enter "Select Device", click the {+} in the upper right corner to add the FRX lawn mower

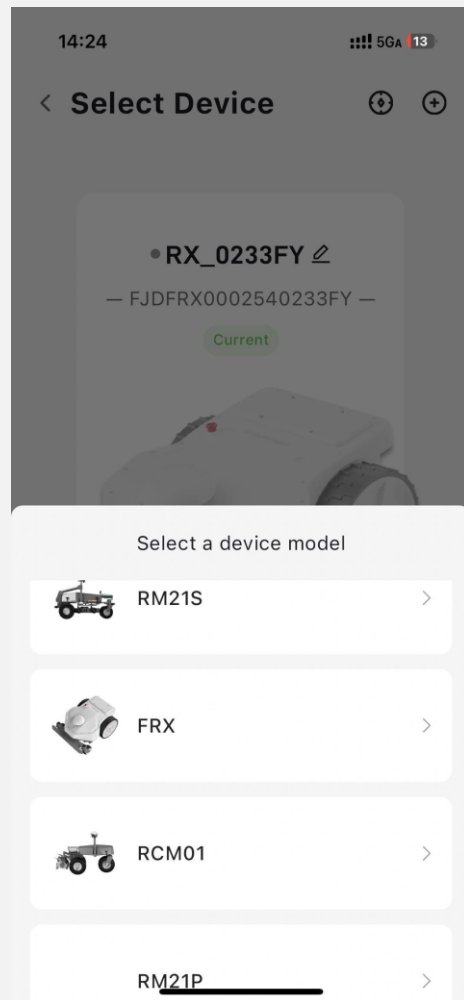

4. Turn on your phone's Bluetooth, and activate the lawn mower FRX according to the app's instructions

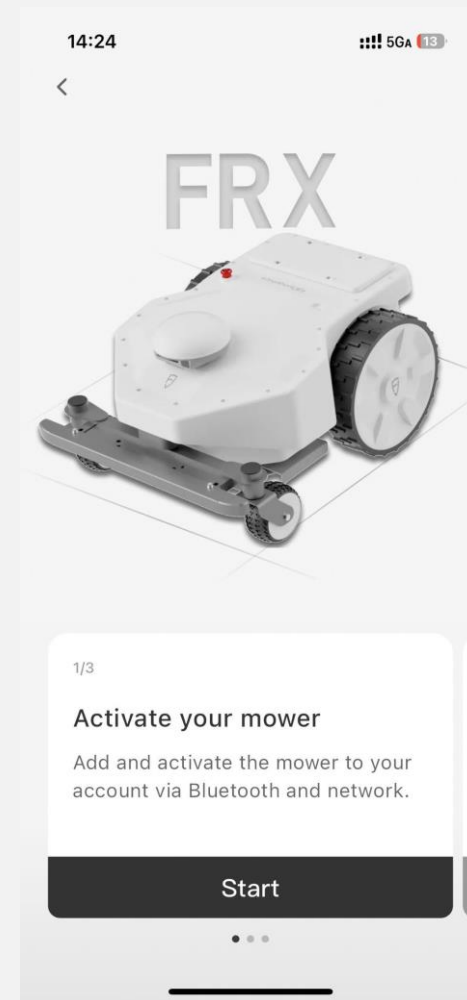



## Connect to Wi-Fi or 4G

Navigate [ Settings ] -> [ Network Settings ], configure either Wi-Fi or 4G network connection according to the app's instructions.

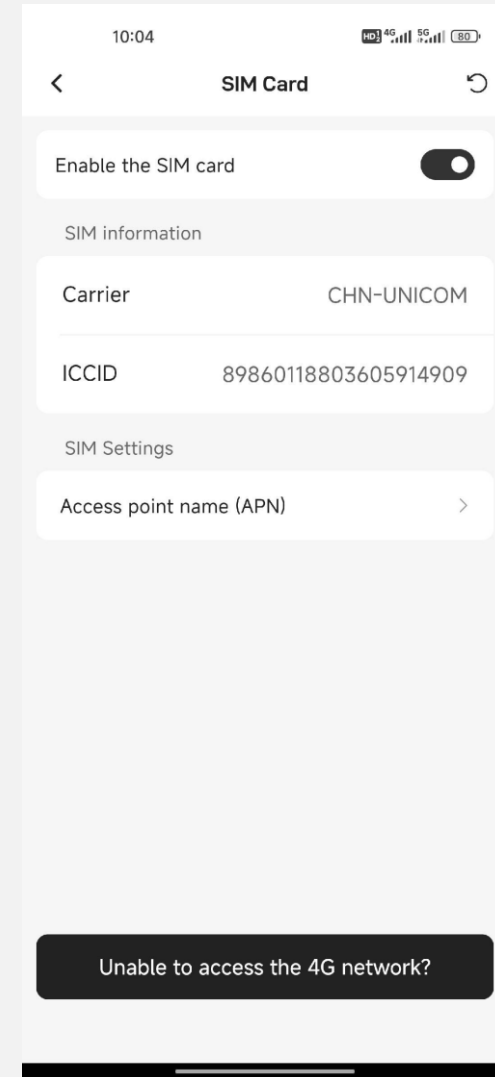
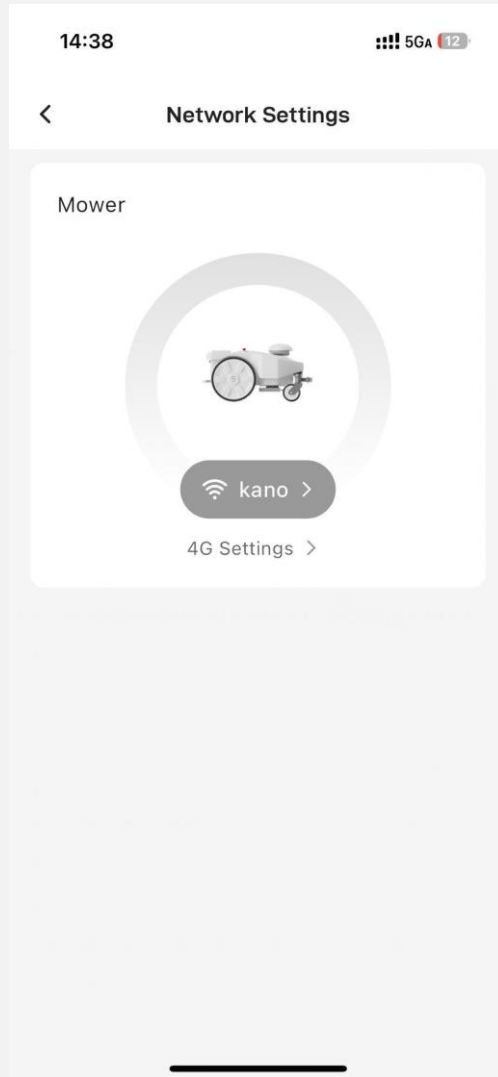



## Connect to Wi-Fi or 4G

**NTRIP Protocol: there is no need of installing RTK base station.**

**Simply enter your NTRIP account information at [ Advanced App Settings ] -> [ Positioning Mode] -> click {NTRIP Mode} to start obtaining regional RTK correction services**

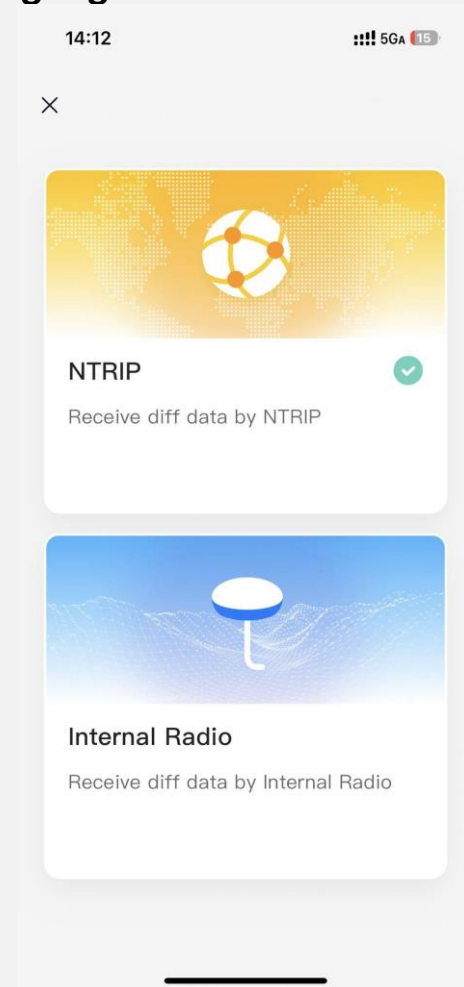



# Mapping & Operation

Follow the app instructions to define the virtual boundaries of your terrain and program the preferred mowing schedule

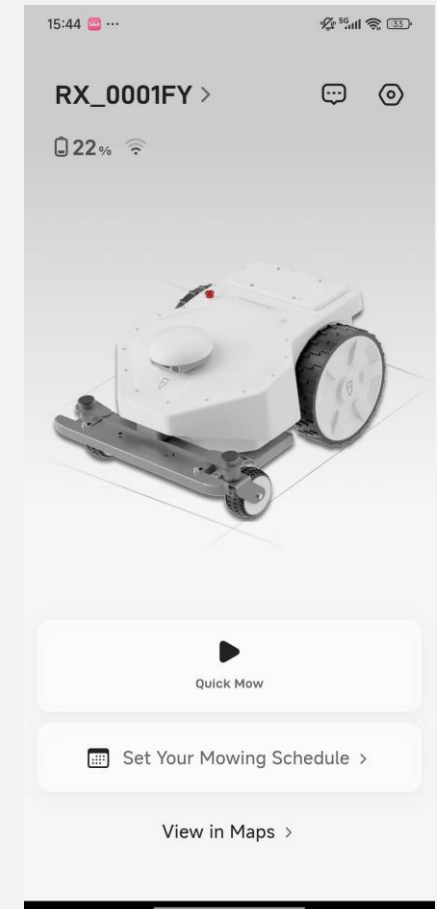
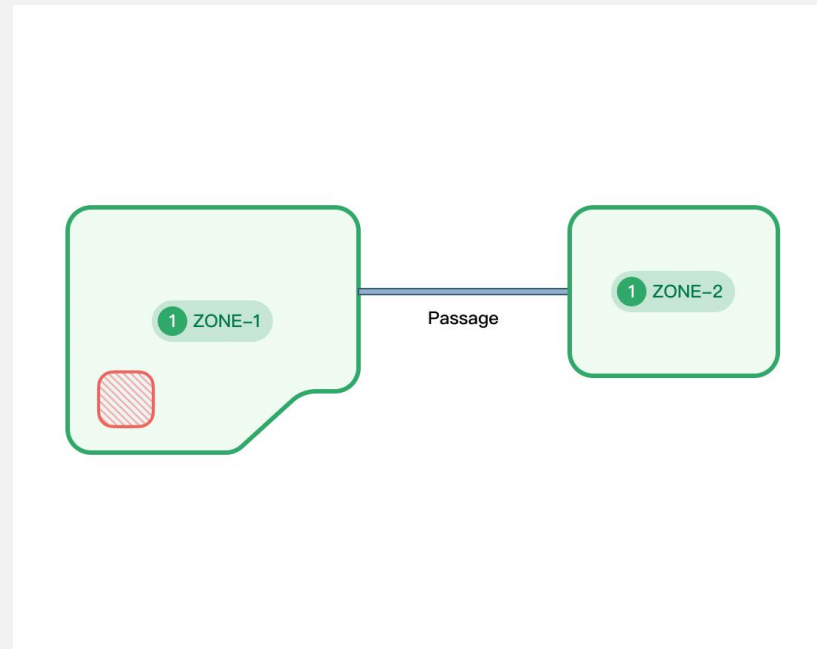
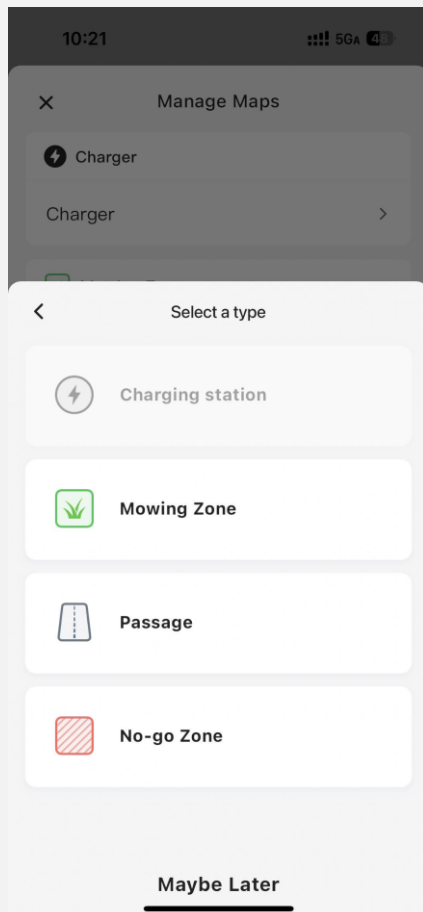

# Create for a Better World

